

Article number: 021816025186

Description: Clamp with bracket and rubber
SPGU 6025. 186/30 SK

Measures

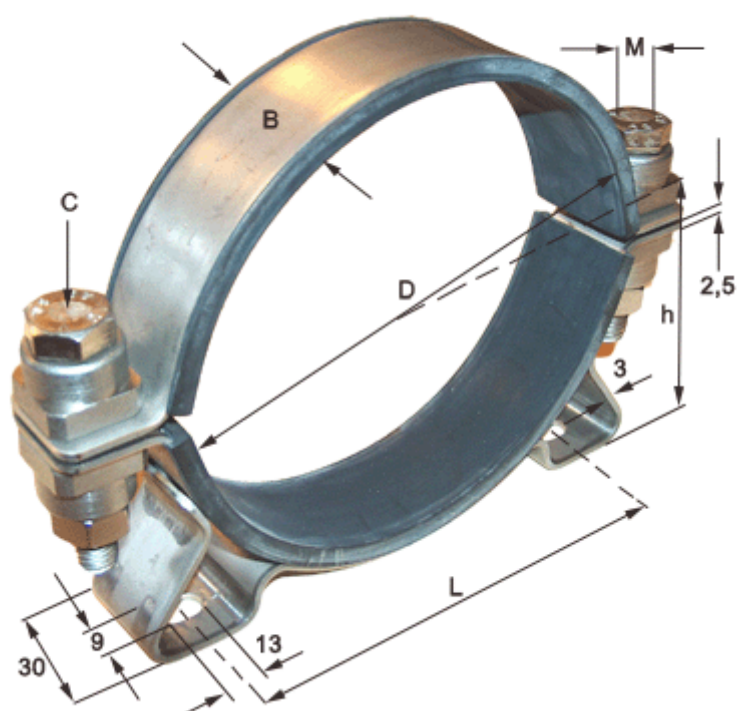

C (screw type) = SK hexagon screw

Diameter D = 186

h = 102

L = 148

Width B = 30